

The logo for DONE, featuring the word "DONE" in a bold, teal, sans-serif font. The letter "D" is stylized with a white circular element on its left side. The logo is contained within a white rounded square with a thin teal border.

MXG SERIES LED DRIVERS

DL-100W-DX-MXG SPEC V1.0

Features

- Class I structure
- Input voltage: 120-277 V ~ 50/60 Hz
- Efficiency :91%(Typ.)
- Constant power drive and constant current output control mode
- Metal shell structure, protection grade: IP67
- Lightning protection level: differential mode 6kV, common mode 15kV
- Function selection:
 - DALI-2 communication protocol (IEC62386-101/102/207)
 - Linear dimming, logarithmic dimming, scene control...
 - Auxiliary source: 12V/300mA
- Lifetime design: 5 years

Applications

Road lighting、 Industrial lighting、 Venue lighting
 Floodlight lighting、 Landscape lighting 、 Plant lighting

Model list

Model NO.	Input voltage	Output power	Output voltage	The default current	Eff.	T.H.D	PF
DL-100W-V143DX-MXG	120-277V 50/60Hz	100W	71-143Vdc	0.7A	≥91%	<10%	≥0.95
DL-100W-V56DX-MXG	120-277V 50/60Hz	100W	25-56Vdc	2.4A	≥89.5%	<10%	≥0.95

Note :

1. Test conditions of the above parameters: Ta=25℃, 230Vac input, full load operation for 30 minutes;
2. When the input is less than 108Vac,the output power range is 50W±20%.When input 120-277VAC, rated power 100W, Please refer to “THE OUTPUT POWER VS INPUT VOLTAGE” curve chart for details.

Input characteristics

Parameter	Min	Typ.	Max	Note
Rated input voltage	120Vac	230Vac	277Vac	
Input voltage range	108Vac		305Vac	
Rated frequency	47Hz	50/60Hz	63Hz	
Power factor	0.95	-	-	@230Vac full load, rated input voltage
Power factor	0.9	-	-	65%-100% load, 100-277VAC input
T.H.D.	-	-	10%	@230Vac full load
T.H.D.	-	-	20%	65%-100% load, 120-277VAC input
Input current	-	-	1.1A	@120Vac full load
Inrush current	-	-	70A	230Vac, cold start (25°C)

Output characteristic

Parameter	Min	Typ.	Max	Note
Rated current				
DL-100W-V56DX-MXG	-	1.8A	-	
DL-100W-V143DX-MXG	-	0.7A	-	
Output current range				
DL-100W-V56DX-MXG	1.3A	-	2.8A	
DL-100W-V143DX-MXG	0.5A	-	1.05A	
Output voltage range				
DL-100W-V56DX-MXG	25V	-	56V	
DL-100W-V143DX-MXG	71V	-	143V	
Rated power(90-120Vac)	-	50W	100W	The derating begins when the input voltage is less than 108Vac
Rated power(120-277Vac)	-	100W	-	
No-load voltage				
DL-100W-V56DX-MXG	-	-	75V	
DL-100W-V143DX-MXG	-	-	190V	
Efficiency@120Vac				
DL-100W-V56DX-MXG	86%	88%	-	full load@120Vac
DL-100W-V143DX-MXG	87%	89%	-	

Output characteristic

Parameter	Min	Typ.	Max	Note
Efficiency@230Vac				
DL-100W-V56DX-MXG	88%	90%	-	full load@230Vac
DL-100W-V143DX-MXG	89%	91%	-	full load@230Vac
Output Current Ripple	-	5% I _{omax}	-	100% load , 20 MHz BW ; Ripple =rms/ average
Accuracy of output current	-5%	-	+5%	full load
Line regulation	-3%	-	+3%	full load
Load regulation	-3%	-	+3%	full load
Starting time	300 ms	-	1000 ms	Full load@120-277Vac
Auxiliary source output voltage	10.8V	12V	13.2V	-
Auxiliary source output current	0 mA	-	300 mA	Reference ground is "Dim -"
Auxiliary source output transient peak current @6W	-	-	500 mA	In a 5.0ms cycle, the maximum duration of the maximum peak current of 500mA is 2ms, and the average value must not exceed 250mA

Note:

1. The output current range is limited by the input and output voltage, please refer to "I-V WORKING AREA" for details.
2. When the output voltage is in the constant power range, the current accuracy is -5%~+5%; when the output voltage is below the constant power range, the current accuracy is -10%~+10%;

Dimming characteristic

Dimming function	Min	Typ.	Max	Instructions
DA+, DA- High voltage level	9.5V	16V	22.5V	
DA+, DA- Low voltage level	-	0V	6.5V	
DA+, DA- Current	-	-	2mA	
Dimming output range	10%Iout	-	100%Iout	

Note:

- 1、 DA+, DA- support the maximum 310Vac misconnection
- 2、 The standby power consumption is less than 0.5W when it is turned off

Protection

Function	Function instructions
Input under-voltage protection	When the input voltage is less than 108Vac $\pm 10\%$, the output power gradually decreases.
Output overload protection	Protection mode:hiccup mode,recovers automatically after fault condition is removed.
Output short circuit protection	Hiccup mode:recovers automatically after fault condition is removed
Over temperature protection	Self-recovery type: when the housing temperature is greater than 90℃, the output power decreases gradually.
Output over-voltage protection	Protection mode: Hiccup mode or clamped in output highest voltage , the product is not damaged, LED driver works normally after fault condition is removed.

Note:

1. Unless otherwise specified, all specifications and parameters shall be measured at the conditions of 230Vac (50Hz), rated load and 25℃ of ambient temperature;
2. Including setting error, line regulation and load regulation.

Environmental

Environmental categories	Parameter
Working temperature	-40 ~ +55°C @200-277Vac, -40 ~ +45°C @120-200Vac (refer to "Life Curve ")
Max.Case Temp.	-40 ~ 90°C
Working humidity	20 ~ 95% RH, non condensing
Storage temperature, humidity	-40 ~ +80°C, 10 ~ 95% RH
Resistant to vibration	10 ~ 500Hz, 5G 12 min/cycle, X, Y, Z axis 72 min each
MTBF	230Khrs min. MIL-HDBK-217F (Ta=25°C)
Lifetime	75,000 hours @Tcase≤75°C, 230Vac, 80% Load, Please refer to "Tcase VS Lifetime" section

Safety and EMC

Safety categories	Standard
Safety	GB19510.1、GB19510.14、EN61347-1、EN61347-2-13、IEC61347-1、IEC61347-2-13、AS/NZS61347.1、AS61347.2.13、EN 62384、 UL8750;
EMC	EN 55015、 EN 61000-3-2 、 GB/T 17743、 GB17625.1、 EN 61000-3-3
Surge protection	Differential mode L-N ±6KV (2 ohm) ,common mode L, N-PE± 15 KV (12 ohm) ; Refer to IEC61000-4-5 2014 Criterion B
High-pot test	I/P-O/P:3.75KVac I/P-PE :1.5KVac O/P-PE : 0.5KVac I/P-DIM:3.75KVac O/P-DIM:1.5KVac
Insulation impedance	I/P-PE:100MΩ / 500VDC; I/P-O/P:100MΩ / 500VDC / 25°C/ 70% RH
Leakage current	<0.7mA@277Vac
DALI-2 standards	Instruction
DALI-2	IEC 62386-101、 IEC 62386-102、 IEC 62386-207

Note:

1. The driver is considered as a component that will be operated in combination with the final equipment. Since EMC performance will be affected by the complete installation,the final equipment manufacturers must re-qualify EMC Directive on the complete installation again.
2. DALIpart:101、 102、 207

I-V Working area

Output voltage VS output current of DL-100W-V143DX-MXG(input: 120-277Vac)

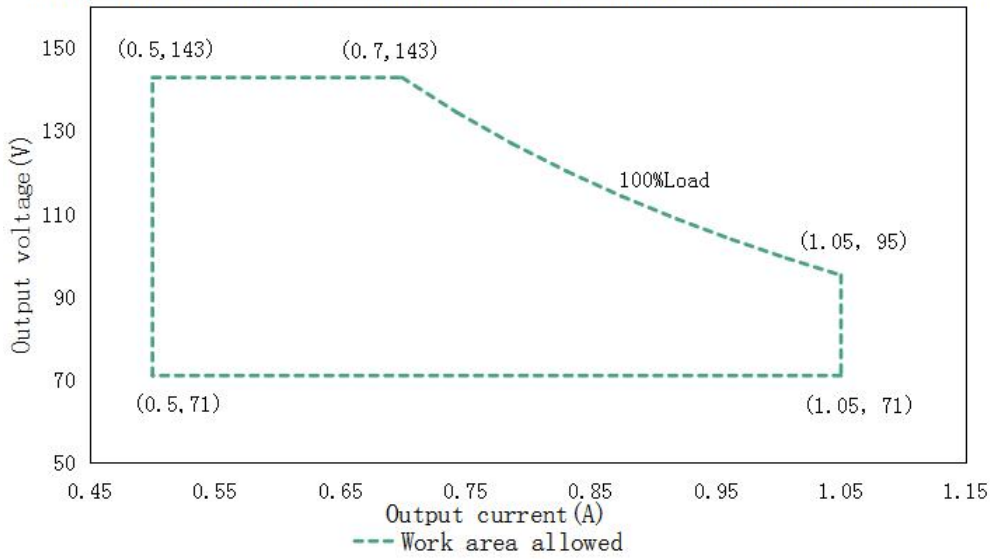

Load	Output								
Load working Voltage	71V	80V	89V	95V	107V	116V	125V	134V	143V
Io_MAX	1.05A	1.05A	1.05A	1.05A	0.93A	0.86A	0.8A	0.74A	0.7A
Po_MAX	74.5W	84W	93.5W	100W	99.51W	99.76W	100W	99.16W	100W

Output voltage VS output current of DL-100W-V56DX-MXG(input: 120-277Vac)

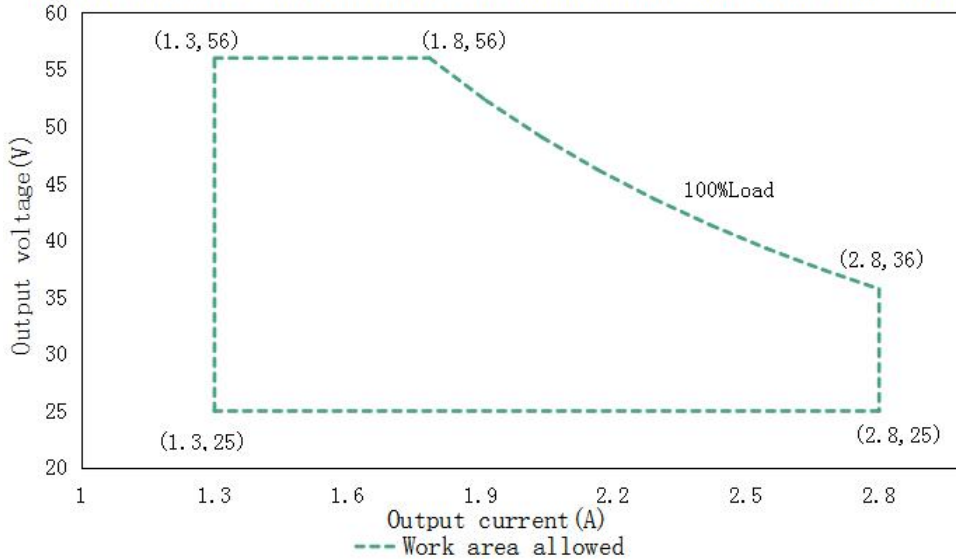

Load	Output								
Load working Voltage	25V	28V	32V	36V	40V	43V	48V	52V	56V
Io_MAX	2.8A	2.8A	2.8A	2.8A	2.5A	2.32A	2.08A	1.92A	1.8A
Po_MAX	70W	78.4W	89.6W	100W	100W	100W	99.84W	99.84W	100W

Eff. VS Output voltage(DL-100W-V143DX-MXG)

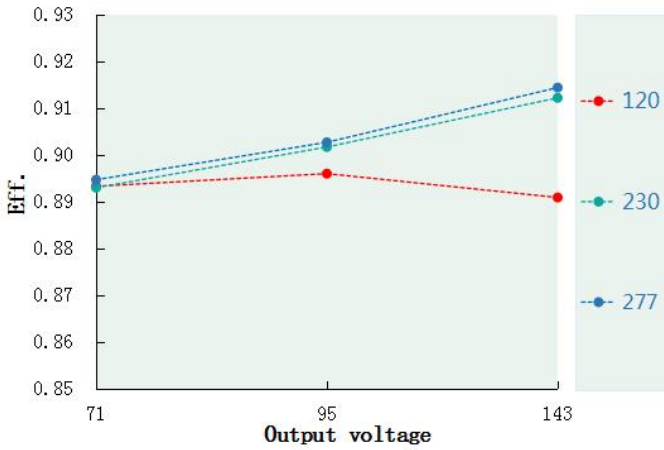

Eff. VS Output voltage(DL-100W-V56DX-MXG)

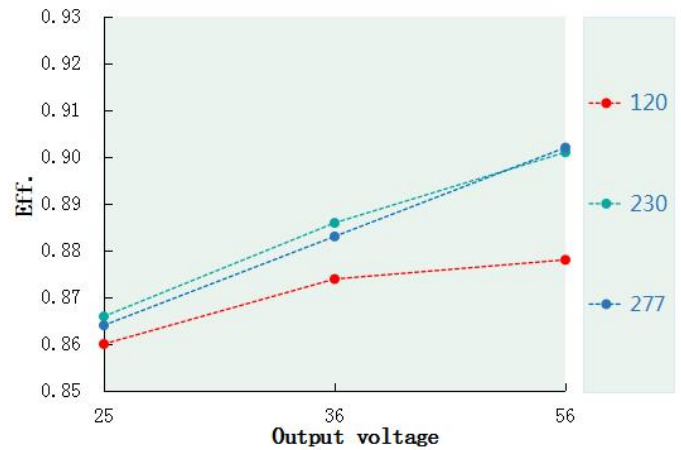

Power factor VS Input voltage(DL-100W-V143DX-MXG)

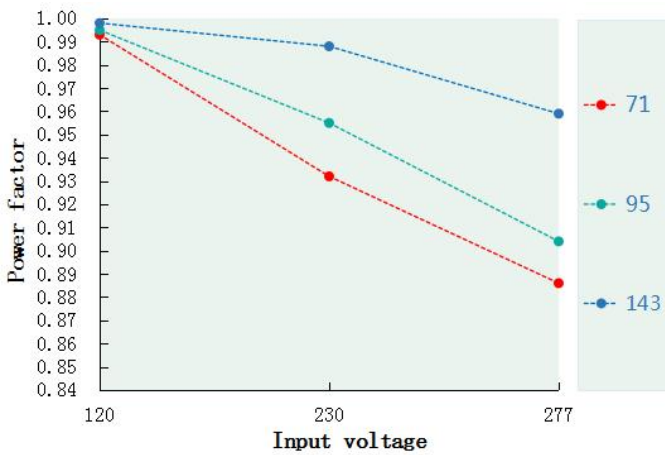

Power factor VS Input voltage(DL-100W-V56DX-MXG)

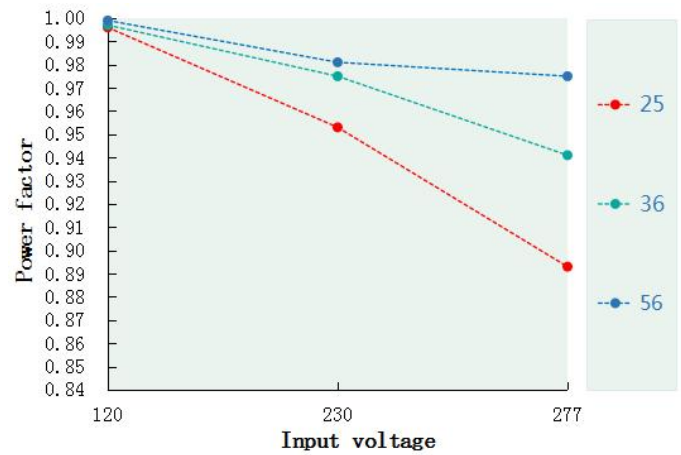

T.H.D. VS Output voltage(DL-100W-V143DX-MXG)

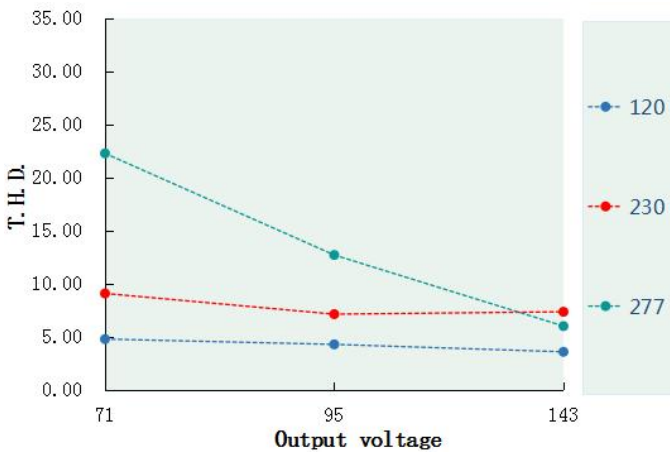

T.H.D. VS Output voltage(DL-100W-V56DX-MXG)

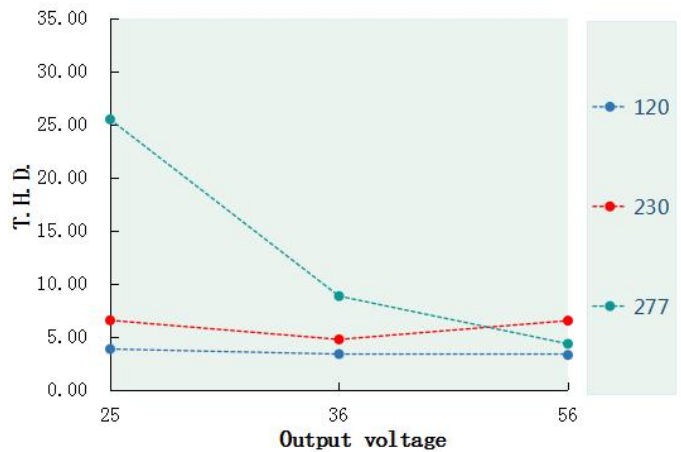

Tcase VS Lifetime (DL-100W-DX-MXG)

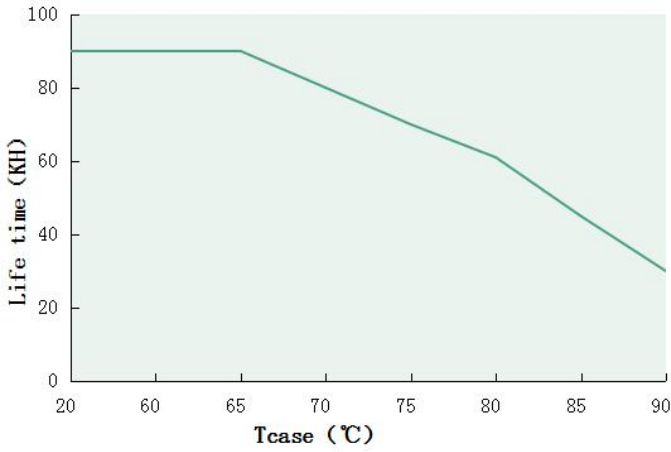

Output power VS Tcase (DL-100W-DX-MXG)

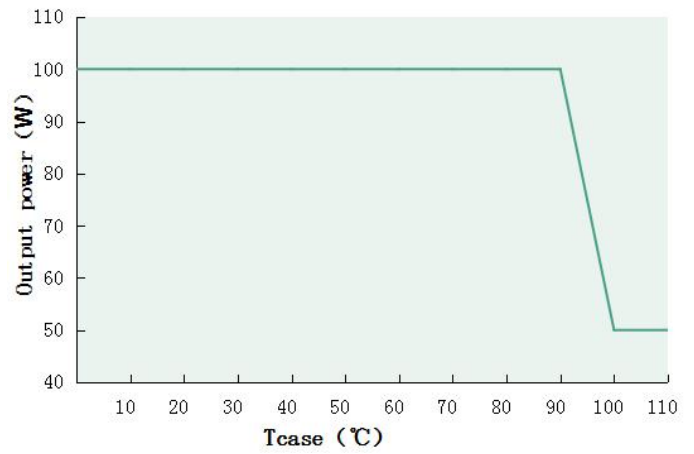

Inrush current(DL-100W-DX-MXG)

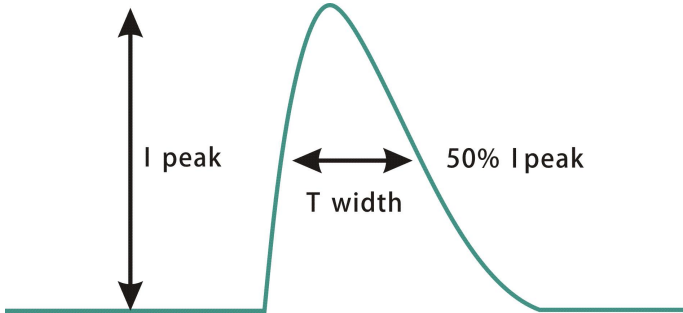

Input voltage	Peak current	T(@50% Peak current)
120Vac	25.4A	188us
230Vac	51.8A	188us
277Vac	61A	206us

Output power VS Input voltage

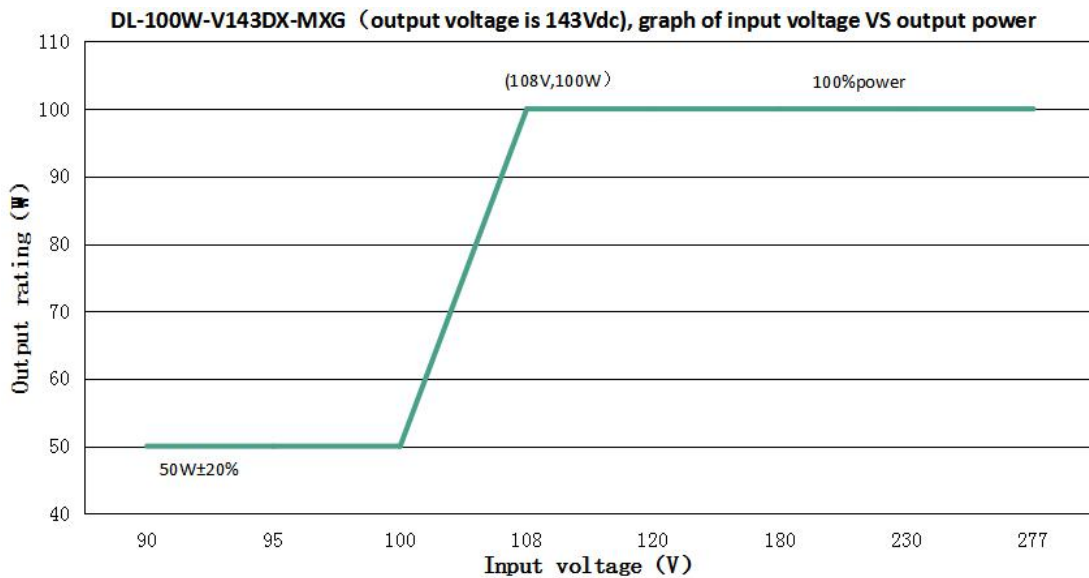

DL-100W-V143DX-MXG (When the output voltage is 143Vdc, the rated output current value and output power corresponding to different input voltage)

Input Voltage	90Vac	95Vac	100Vac	108Vac	120Vac	180Vac	230Vac	277Vac
Iout	0.35A	0.35A	0.35A	0.7A	0.7A	0.7A	0.7A	0.7A
Pout	50W	50W	50W	100W	100W	100W	100W	100W

- Note:**
- 1.Input voltage will fluctuate,resistance error and other factors.At the decrease or increase of power (Vin=108Vac),it will move left and right,with the range of 108V .
 - 2.When the input voltage is 90-108Vac,the output power range is 50W±20%.

Output power VS Input voltage

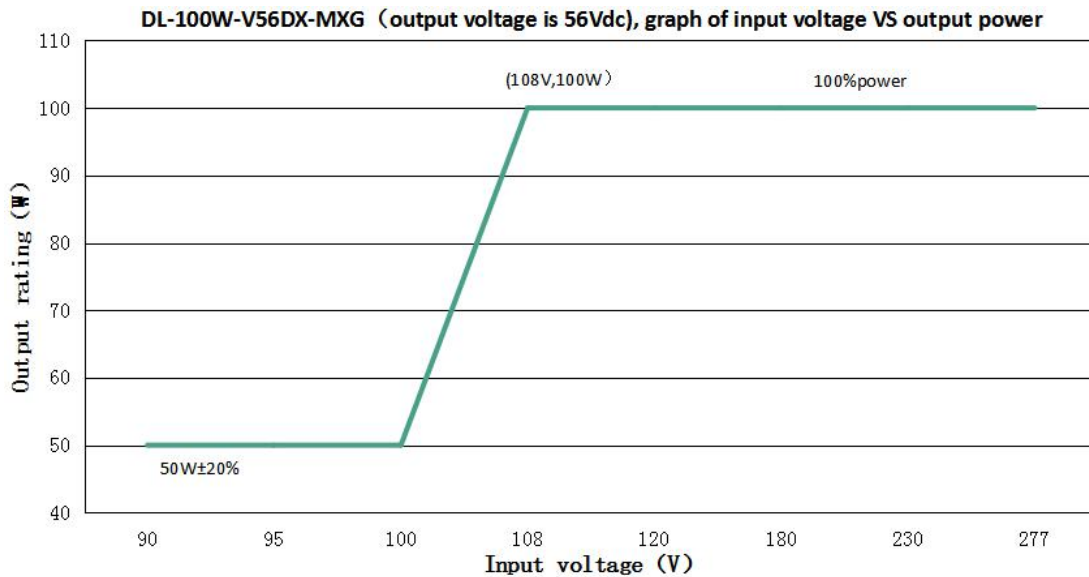

DL-100W-V56DX-MXG (When the output voltage is 56Vdc, the rated output current value and output power corresponding to different input voltage)

Input Voltage	90Vac	95Vac	100Vac	108Vac	120Vac	180Vac	230Vac	277Vac
Iout	0.9A	0.9A	0.9A	1.8A	1.8A	1.8A	1.8A	1.8A
Pout	50W	50W	50W	100W	100W	100W	100W	100W

- Note:**
- 1.Input voltage will fluctuate,resistance error and other factors.At the decrease or increase of power (Vin=108Vac),it will move left and right,with the range of 108V .
 - 2.When the input voltage is 90-108Vac,the output power range is 50W±20%.

Dali-2 dimming curve

Logarithmic Dimming Curve

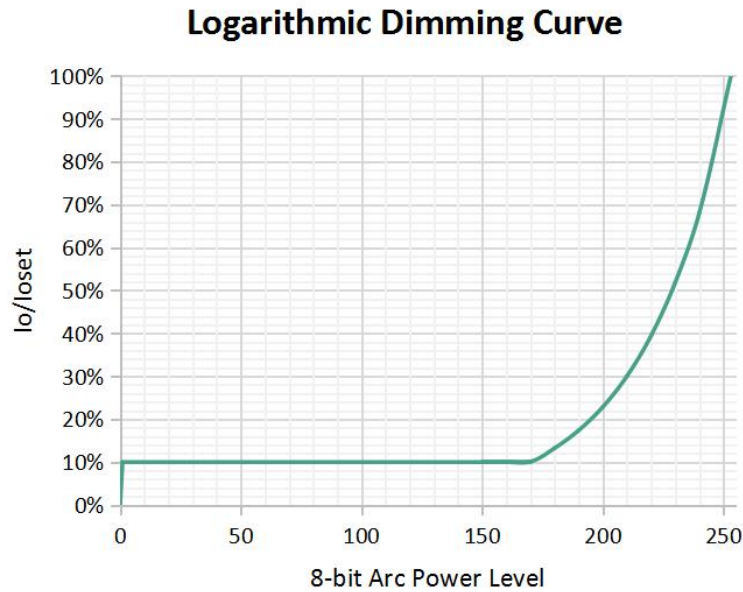

Linear Dimming Curve

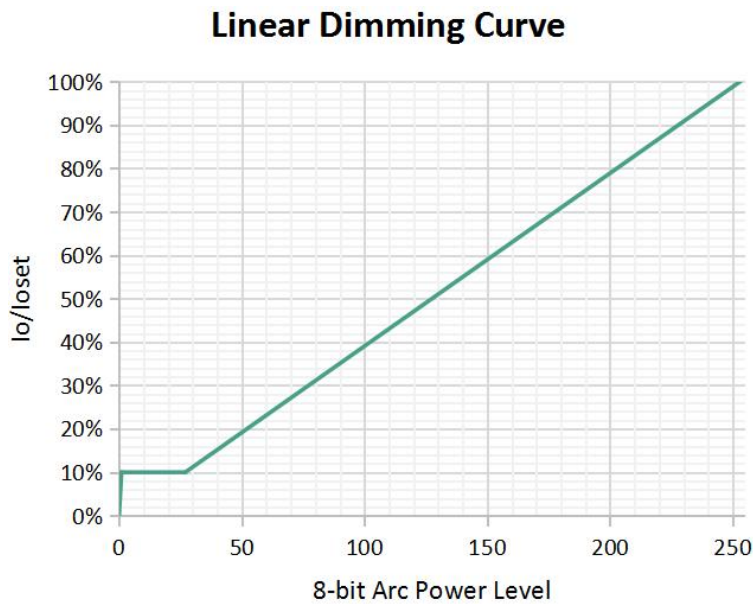

Note:

- 1.Factory default logarithmic dimming.

Mechanical specification

Size (mm) L153*W63*H32

DL-100W-V56DX-MXG
 DL-100W-V143DX-MXG

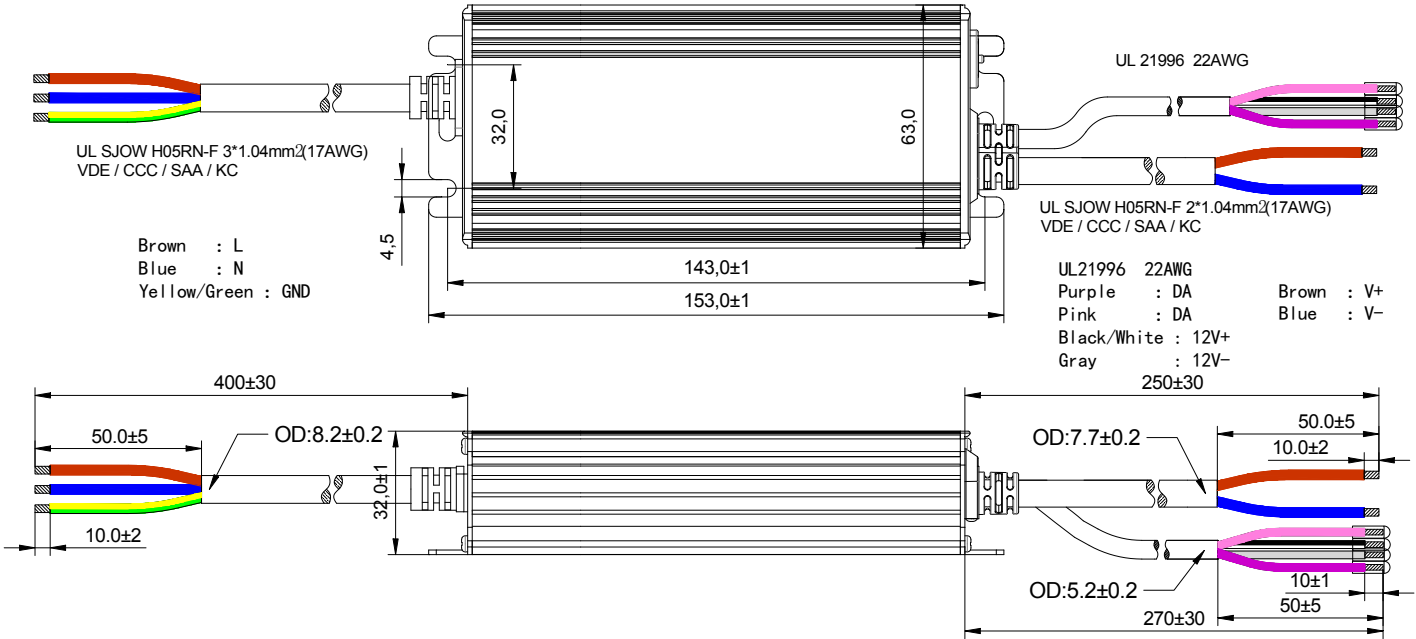

Weight

Weight 545 g

Packaging

Packaging (mm) L475*W350*H160

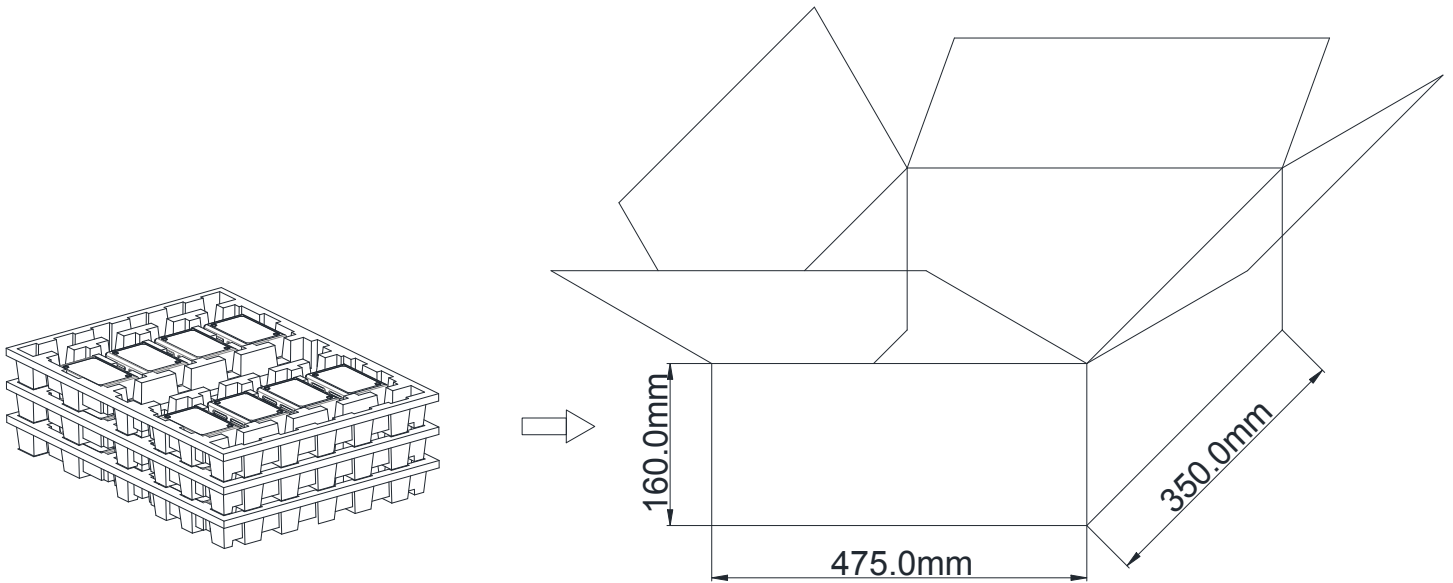

Note: One Carton 3 layers and 8 pcs each layer, total 24pcs/carton.

Note:

1. According to the certificate obtained by the LED DRIVER, the LED DRIVER with the English label is sold in Europe, America and India.
2. The LED DRIVER with Chinese label is only used for China market.

Version

DATE	DESCRIPTION	REV.	CHECK
2022.12.9	Initial version.	V1.0	

MANUFACTRUER		
EDIT	CHECK	APPROVE