

| | | | | |
|--|--------------|----------------------------|-----|-----|
|  GUANGDONG DONE POWER TECHNOLOGY CO.,LTD <small>Service hotline: 400 0760 585 Website: www.donepower.com.cn</small> | Application | DONE WATERPROOF LED DRIVER | | |
| | Product Line | DL-50W-S/A-MAP | REV | 1.4 |

Guangdong Done Power Technology Co.,Ltd.

SPECIFICATION FOR APPROVAL

| | |
|-------------|----------------|
| CUSTOMER : | |
| MODEL NO. : | DL-50W-S/A-MAP |
| VERSION: | V1.4 |
| | |

CUSTOMER

| | | |
|------------------|-------|---------|
| TEST | CHECK | APPROVE |
| | | |
| CUSTOMER REMARKS | | |

Please return to us one copy of "SPECIFICATION FOR APPROVAL" with you approved signature..

MANUFACTURE

| | | |
|------|-------|---------|
| EDIT | CHECK | APPROVE |
| 吕晓凤 | | |

Guangdong Done Power Technology Co.,Ltd.

No. 3-1&3-2, Kanglong 3rd Road, XinMao Industry Zone, Henglan Town,
 Zhongshan City, Guangdong Province, P. R. China Post code:528478
 TEL:0760-89838399 89838379 FAX:0760-89831157 89838396

| | | | | |
|--|--------------|----------------------------|-----|-----|
|  GUANGDONG DONE POWER TECHNOLOGY CO.,LTD Service hotline: 400 0760 585 Website: www.donepower.com.cn | Application | DONE WATERPROOF LED DRIVER | | |
| | Product Line | DL-50W-S/A-MAP | REV | 1.4 |

■ VERSION

| DATE | CAUSES OF CHANGE | REV. | CHECK |
|------------|---|------|-------|
| 2020.02.24 | Initial version | V1.0 | |
| 2020.03.04 | Change the product picture (P3) | V1.1 | |
| 2020.04.14 | Add voltage range on page 4:90-305Vac | V1.2 | |
| 2022.2.17 | Update dimension drawing | V1.3 | |
| 2022.3.11 | 1.. update the company LOGO and company name. | V1.4 | |
| | | | |
| | | | |
| | | | |
| | | | |
| | | | |
| | | | |
| | | | |
| | | | |
| | | | |

| | | | | |
|--|--------------|----------------------------|-----|-----|
|  GUANGDONG DONE POWER TECHNOLOGY CO.,LTD Service hotline: 400 0760 585 Website: www.donepower.com.cn | Application | DONE WATERPROOF LED DRIVER | | |
| | Product Line | DL-50W-S/A-MAP | REV | 1.4 |

■ FEATURES

- ◇ Class I structure
- ◇ Input Voltage:100-277V ~ 50/60Hz
- ◇ Efficiency 88%
- ◇ Constant power drive , Constant current output control mode
- ◇ Metal clad construction , level of protection : IP67
- ◇ Lightning protection level : difference module 4kV ,
common mode 6kV
- ◇ Long life design , 5 years warranty
- ◇ Output current can be adjusted Externally
- ◇ The dimming function : Three in one dimming
(Only S series)



■ TYPICAL APPLICATIONS

Road lighting、Industrial lighting、The venue lighting
floodlighting、landscape lighting



■ MODEL LIST

| Model | AC Input | Output power | Output voltage | Output current | Efficiency | T.H.D | PF |
|------------------------------------|---------------------|--------------|----------------|----------------|------------|-------|-------|
| DL-50W-V38S-MAP DL-50W-V38A-MAP | 100-277V 50/60Hz | 50W | 20-38Vdc | 1.5A | >87.5% | <10% | >0.95 |
| DL-50W-V58S-MAP DL-50W-V58A-MAP | 100-277V 50/60Hz | 50W | 32-58Vdc | 0.9A | >88% | <10% | >0.95 |

Remark :

1. Default tested at 230Vac,full load with 30 minutes,Ta:25°C.
2. 100-180Vac , Pout:25W±20% ; 200-277Vac , P rated 50W.

| | | | | |
|---|--------------|----------------------------|-----|-----|
|  GUANGDONG DONE POWER TECHNOLOGY CO.,LTD Service hotline: 400 0760 585 Website: www.donepower.com.cn | Application | DONE WATERPROOF LED DRIVER | | |
| | Product Line | DL-50W-S/A-MAP | REV | 1.4 |

■ SPECIFICATION

◇ INPUT

| | |
|--------------------------------|--|
| Rated voltage | 100 - 277Vac |
| Voltage Range | 90-305Vac |
| Frequency | 50/60Hz |
| Power factor(PF) | PF>0.95 @230Vac full load |
| Total harmonic distortion(THD) | THD<10% @230Vac full load |
| Input current | I _{in} <0.41A @180Vac full load |
| Inrush current (typ.) | Cold start 65A @230Vac |

◇ OUTPUT

| Model | DL-50W-V38S-MAP DL-50W-V38A-MAP | DL-50W-V58S-MAP DL-50W-V58A-MAP |
|--------------------------------|------------------------------------|------------------------------------|
| Rated current | 1.35A | 0.85A |
| Output current range | 0.7-1.6A | 0.5-1.2A |
| Output voltage range | 20-38Vdc | 32-58Vdc |
| Rated output power(100-180Vac) | 25W±30% | 25W±30% |
| Rated output power(200-277Vac) | 50W | 50W |
| No load voltage | 50Vdc Max | 70Vdc Max |
| Efficiency | 87.5%@230Vac Full load | 88%@230Vac Full load |
| Accuracy off output current | ±5% | |
| Line regulation | ±5% | |
| Load regulation | ±5% | |
| Setup time | <500ms @230Vac full load | |

Remarks : the range of output current is limited by in-out voltage , For details, please refer to the I-V working area.

| | | | | |
|--|--------------|----------------------------|-----|-----|
|  GUANGDONG DONE POWER TECHNOLOGY CO.,LTD Service hotline: 400 0760 585 Website: www.donepower.com.cn | Application | DONE WATERPROOF LED DRIVER | | |
| | Product Line | DL-50W-S/A-MAP | REV | 1.4 |

◇ Others

| | | |
|----------------------------|------------------------------|-----------------|
| 0-10V Dimming (Optional) | Safety Dimming Voltage Range | 0V - 12V |
| | Dim Range | 0 - 100% |
| | Rated Dim Range | 0V - 10V |
| PWM Dimming (Optional) | PWM High | 9.5V - 10.5V |
| | PWM Low | 0V - 0.3V |
| | PWM Frequency | 300Hz - 2000Hz |
| | PWM Duty | 0 - 100% |
| Resistor Dimming | Resistance | 0Kohm - 100Kohm |
| | Dim Range | 0 - 100% |

Remarks:

1. Output current of dimming port: 100uA (typical value);
2. The maximum withstand voltage of the dimming port is 12V. If the external power supply voltage exceeds 12V or the signal line is reversely connected, the power supply will be damaged.

◇ Protection

| | |
|-----------------------------|--|
| Low Voltage protection | When the input voltage is less than 180Vac, the output power is reduced by about half |
| Over Load protection | Protection mode: hiccup restart mode, automatic recovery after removal of abnormal load conditions |
| Short Circuit Protection | Doze mode, can automatically recover after abnormal conditions are removed |
| Over temperature Protection | When the Tc is over 90 °C , the output power is reduced by about half |
| Over Voltage protection | Protection mode: hiccuping or clamping in output maximum voltage ,Production undamaged,When troubleshooting,Normal operation of power supply |

Remarks:

1. All specifications are tested at 230Vac (50Hz) , rated load, and Ta:25°C.
2. Including setting error, linear adjustment rate and load adjustment rate.

| | | | | |
|--|--------------|----------------------------|-----|-----|
|  GUANGDONG DONE POWER TECHNOLOGY CO.,LTD Service hotline: 400 0760 585 Website: www.donepower.com.cn | Application | DONE WATERPROOF LED DRIVER | | |
| | Product Line | DL-50W-S/A-MAP | REV | 1.4 |

■ ENVIRONMENT

| | |
|------------------------------|---|
| Working temperature | -40 ~ +60°C (Refer to "Derating Curve") |
| Working humidity | 20 ~ 95% RH, non-condensing |
| Storage temperature/humidity | -40~+80°C, 10 ~ 95% RH |
| Resistant to vibration | 10 ~ 500Hz, 5G 12min./1cycle, period for 72min. each along X, Y, Z axes |
| MTBF | 230K hrs min. MIL-HDBK-217F (Ta=25°C) |

■ SAFETY & EMC

| | |
|-----------------------|---|
| Safety | GB19510.1、GB19510.14、EN61347-1、EN61347-2-13、IEC61347-1、IEC61347-2-13、AS/NZS61347.1、AS61347.2.13 ; |
| EMC | EN 55015、EN 61000-3-2 、GB/T 17743、GB17625.1、EN 61000-3-3 |
| Surge level | difference mode L-N \pm 4 KV (2 ohm), common mode L , N-PE \pm 6KV (12 ohm) Refer to IEC61000-4-5 2014 |
| High-pot test | I/P-O/P:3.75KVAC I/P-PE :1.5KVAC O/P-PE : 0.5KVAC I/P-DIM:1.5KVAC |
| Insulation resistance | I/P-O/P:100M Ohms / 500VDC / 25°C/ 70% RH |
| Leakage current | <0.7mA |

Remarks:

The power supply is considered as a component that will be operated in combination with final equipment. Since EMC performance will be affected by the complete installation, the final equipment manufacturers must re-qualify EMC Directive on the complete installation again.

I-V Working Area

(Fig. 1) DL-50W-V38S/38A-MAP(Vin: 200-277Vac) Iout VS Vout

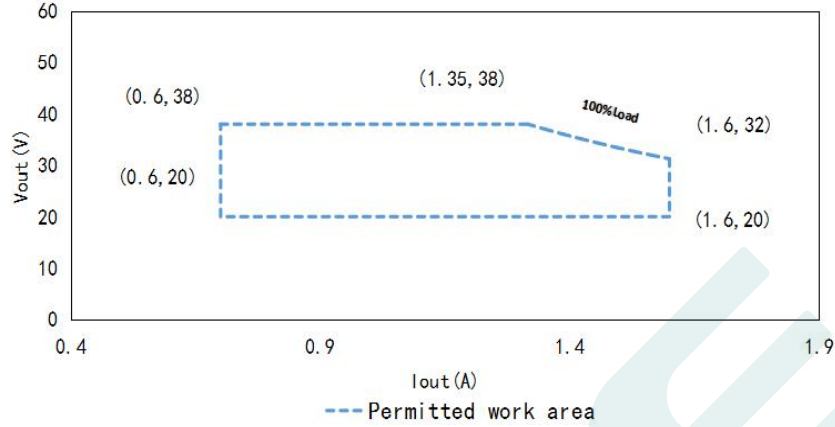

DL-50W-V38S/A-MAP(200-277Vac , Rated output current and output power corresponding to different load voltages)

| Load working Voltage | 20V | 22V | 24V | 26V | 28V | 30V | 33V | 36V | 38V |
|----------------------|------|-------|-------|-------|-------|------|-------|--------|-------|
| Io_MAX | 1.6A | 1.6A | 1.6A | 1.6A | 1.6A | 1.6A | 1.6A | 1.465A | 1.35A |
| Po_MAX | 32W | 35.2W | 38.4W | 43.2W | 44.8W | 48W | 51.2W | 51.3W | 51.3W |

(Fig. 1) DL-50W-V38S/38A-MAP(Vin: 100-180Vac) Iout VS Vout

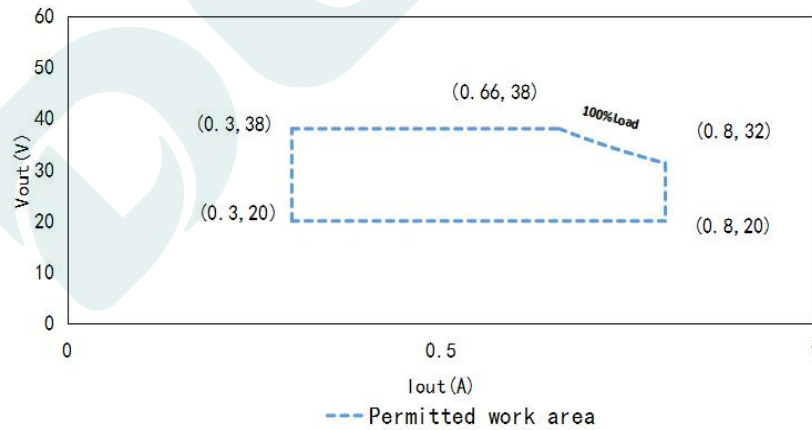

DL-50W-V38S/A-MAP(100-180Vac , Rated output current and output power corresponding to different load voltages)

| Load working Voltage | 20V | 22V | 24V | 26V | 28V | 30V | 33V | 36V | 38V |
|----------------------|------|-------|-------|-------|-------|------|-------|-------|-------|
| Io_MAX | 0.8A | 0.8A | 0.8A | 0.8A | 0.8A | 0.8A | 0.8A | 0.71A | 0.66A |
| Po_MAX | 16W | 17.6W | 19.2W | 21.6W | 22.4W | 24W | 25.6W | 25.6W | 25.6W |

I-V Working Area

(Fig. 1) DL-50W-V58S/58A-MAP (Vin: 200-277Vac) Iout VS Vout

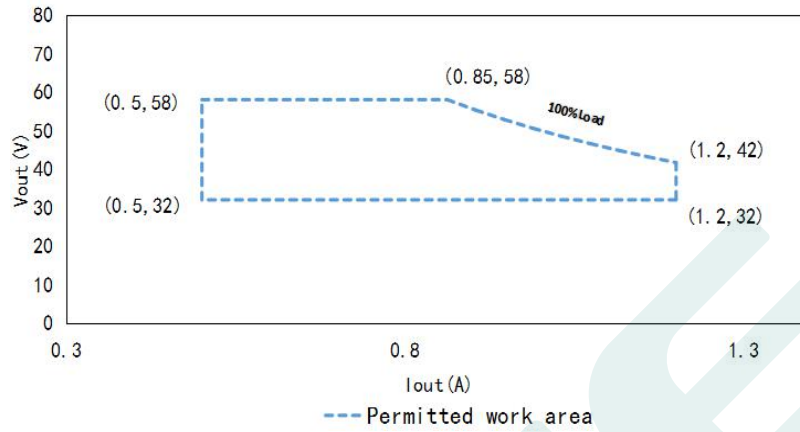

DL-50W-V58S/A-MAP(200-277Vac , Rated output current and output power corresponding to different load voltages)

| Load working Voltage | 32V | 35V | 39V | 42V | 45V | 48V | 50V | 55V | 58V |
|----------------------|-------|-------|-------|-------|-------|-------|-------|-------|-------|
| Io_MAX | 1.2A | 1.2A | 1.2A | 1.2A | 1.17A | 1.07A | 0.98A | 0.91A | 0.85A |
| Po_MAX | 38.4W | 40.8W | 43.2W | 46.8W | 49.3W | 49.3W | 49.3W | 49.3W | 49.3W |

(Fig. 1) DL-50W-V58S/58A-MAP (Vin: 100-180Vac) Iout VS Vout

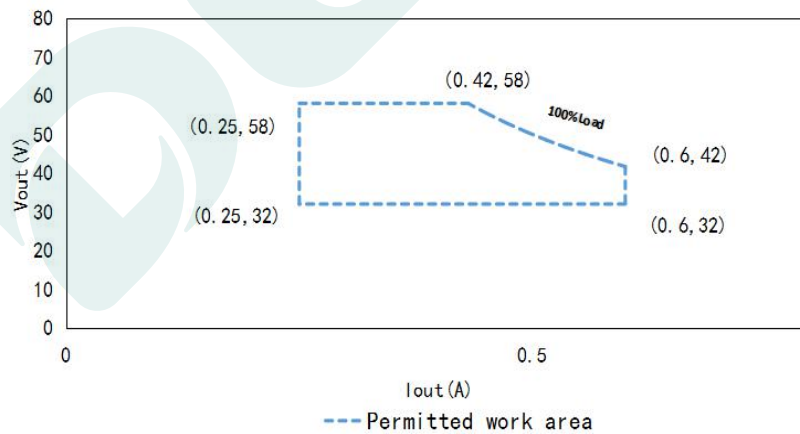

DL-50W-V58S/A-MAP(100-180Vac , Rated output current and output power corresponding to different load voltages)

| Load working Voltage | 32V | 35V | 39V | 42V | 45V | 48V | 50V | 55V | 58V |
|----------------------|-------|-------|-------|-------|--------|--------|-------|--------|-------|
| Io_MAX | 0.6A | 0.6A | 0.6A | 0.6A | 0.559A | 0.503A | 0.49A | 0.455A | 0.42A |
| Po_MAX | 19.2W | 20.4W | 21.6W | 23.4W | 24.6W | 24.6W | 24.6W | 24.6W | 24.6W |

Efficiency VS Vout(DL-50W-V38S-MAP)

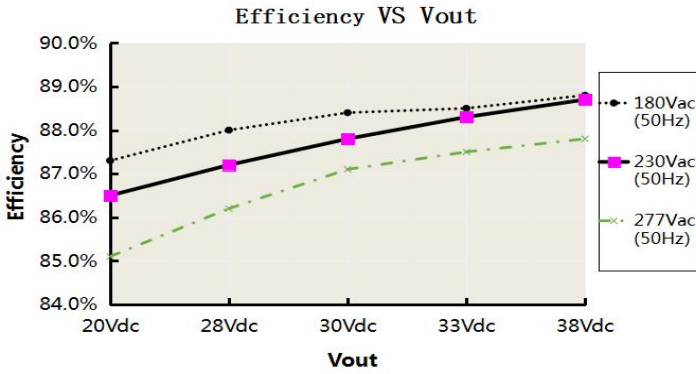

Efficiency VS Vout(DL-50W-V58S-MAP)

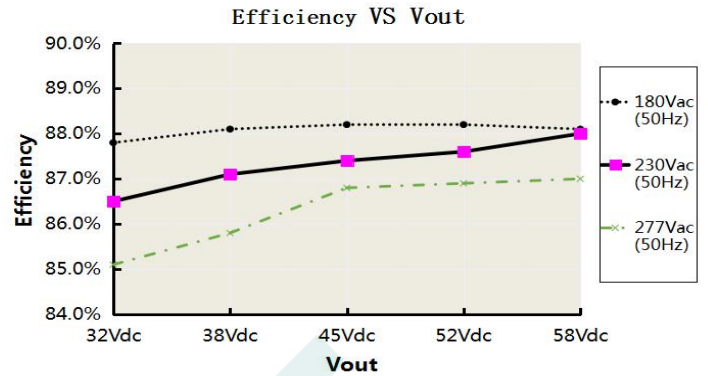

Vin VS PF(DL-50W-V38S-MAP)

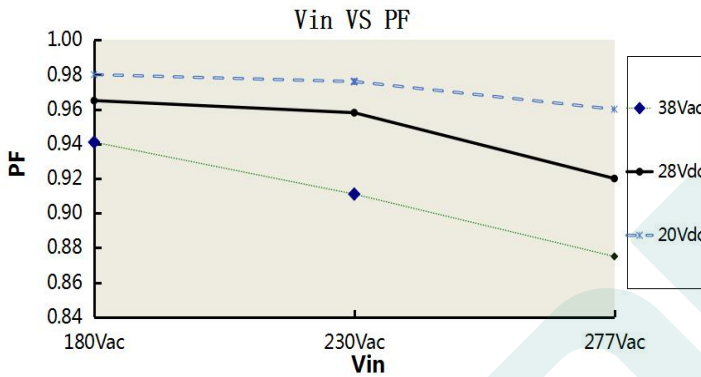

Vin VS PF(DL-50W-V58S-MAP)

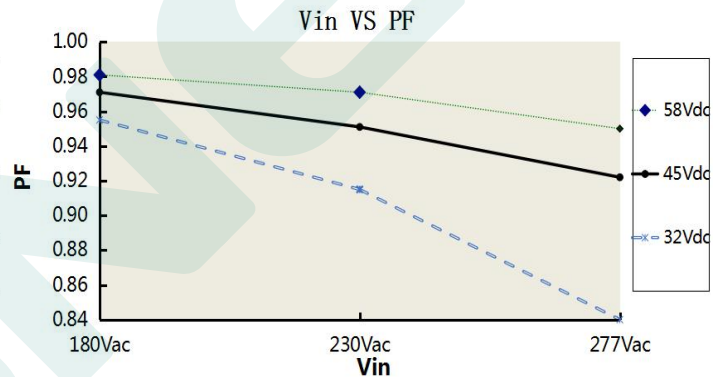

Vout VS THD(DL-50W-V38S-MAP)

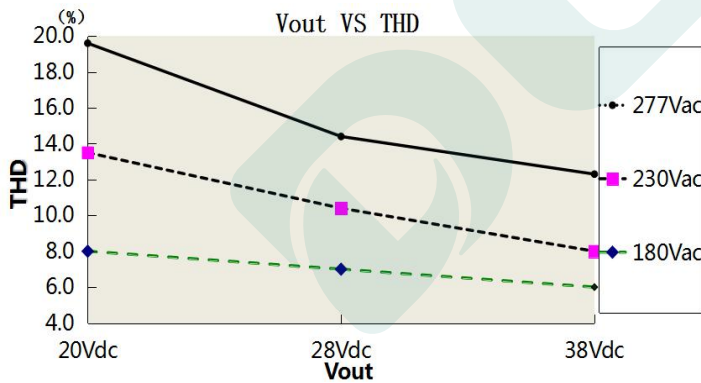

Vout VS THD(DL-50W-V58S-MAP)

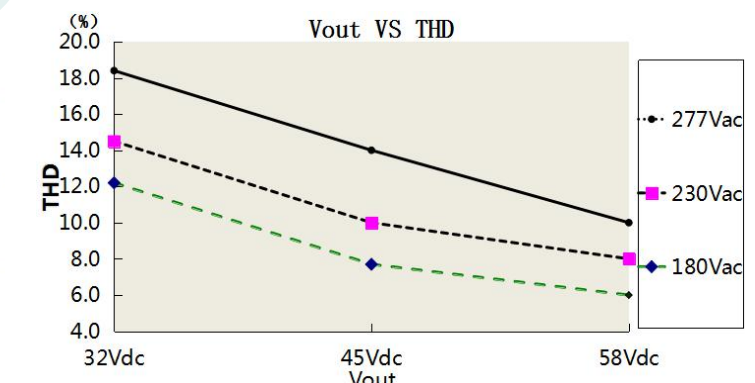

Tc VS Life(DL-50W-S/A-MAP)

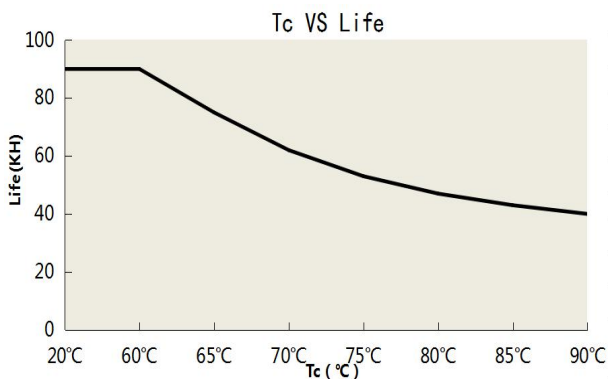

Pout VS Tc

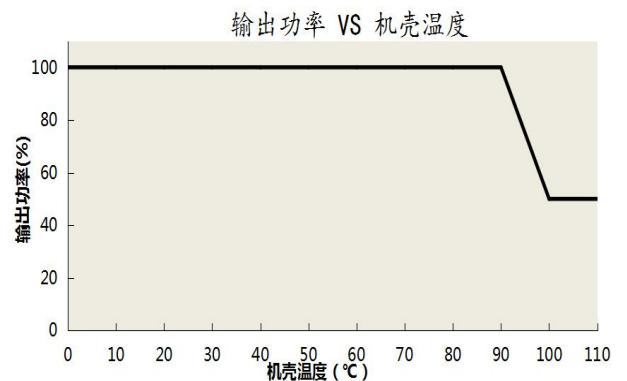

■ Pout VS Vin

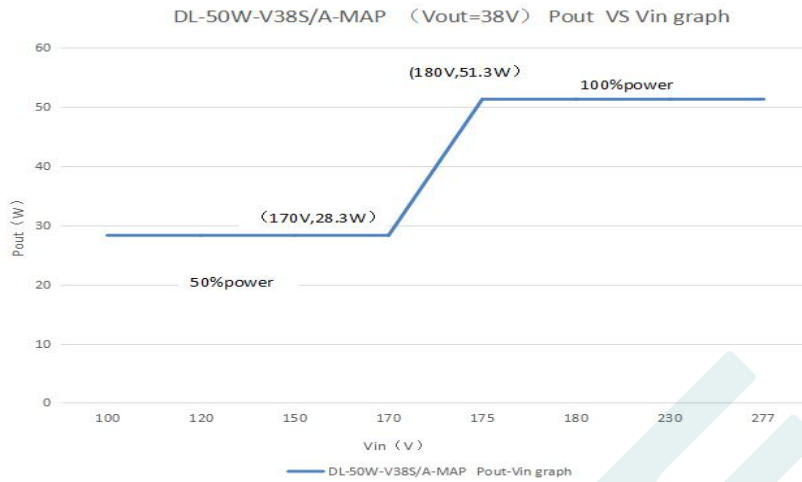

DL-50W-V38S/A-MAP(38Vdc, Rated output current and output power corresponding to different Input voltages)

| Input Voltage | 100Vac | 120Vac | 150Vac | 170Vac | 175Vac | 180Vac | 230Vac | 277Vac |
|---------------|--------|--------|--------|--------|--------|--------|--------|--------|
| Io | 0.75A | 0.75A | 0.75A | 0.75A | 1.05A | 1.35A | 1.35A | 1.35A |
| Po | 28.3W | 28.3W | 28.3W | 28.3W | 51.3W | 51.3W | 51.3W | 51.3W |

■ Pout VS Vin

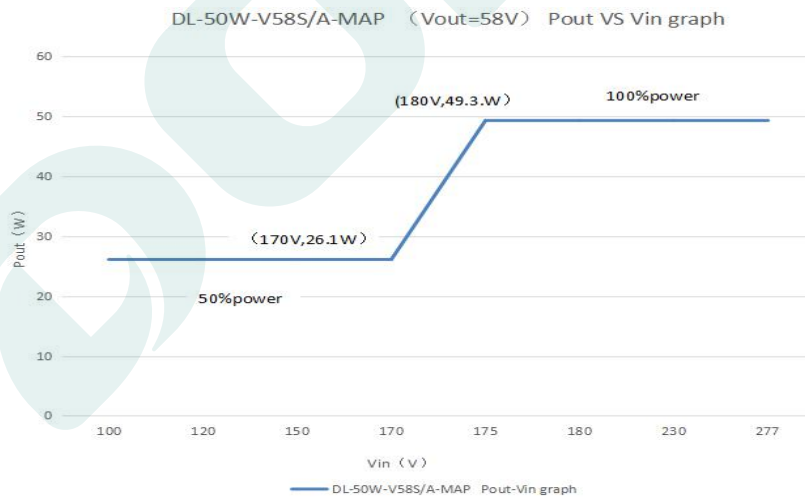

DL-50W-V58S/A-MAP(58Vdc, Rated output current and output power corresponding to different Input voltages)

| Input Voltage | 100Vac | 120Vac | 150Vac | 170Vac | 175Vac | 180Vac | 230Vac | 277Vac |
|---------------|--------|--------|--------|--------|--------|--------|--------|--------|
| Io | 0.45A | 0.42A | 0.42A | 0.42A | 0.66A | 0.85A | 0.85A | 0.85A |
| Po | 26.1W | 26.1W | 26.1W | 26.1W | 49.3W | 49.3W | 49.3W | 49.3W |

Remarks:

1. Due to input voltage fluctuations and resistance errors. When the power decreases or increases (that is, $V_{in} = 150V$ or $V_{in} = 180V$), it will move left and right, and the approximate moving range is $150V \pm 10\%$, $180V \pm 10\%$
2. When the input voltage is 100-180V, the output power range is $25W \pm 20\%$.

■ DIMMING OPERATION

※ 3 in 1 dimming (For S Type)

1. Output constant current level can be adjusted by applying one of the three methodologies between DIM+ and DIM-: 0 ~ 10VDC, or 10V PWM signal or resistance.

Direct connecting to LEDs is suggested. It is not suitable to be used with additional drivers.

Dimming source current from power supply: 100μA (typ.)

◎ Applying additive 0-10Vdc:

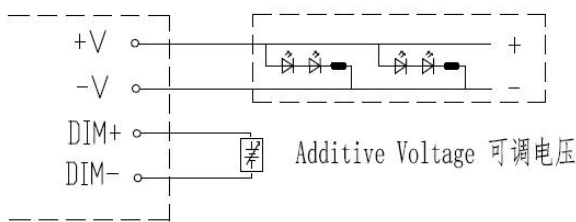

DO NOT connect "DIM- to -V" 请勿将DIM- 与-V相连

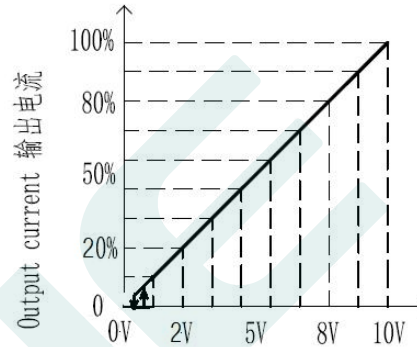

Dimming input: Additive voltage 调光输入: 外加电压

◎ Applying additive 10V PWM signal (Frequency range: 300Hz-2K Hz):

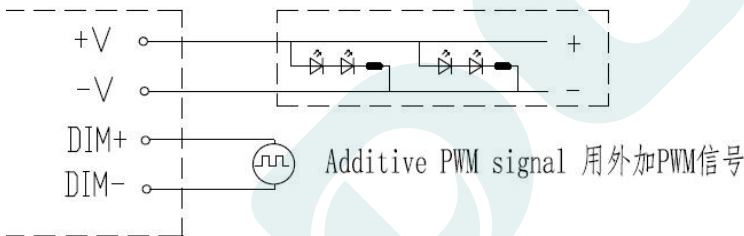

DO NOT connect "DIM- to -V" 请勿将DIM- 与-V相连

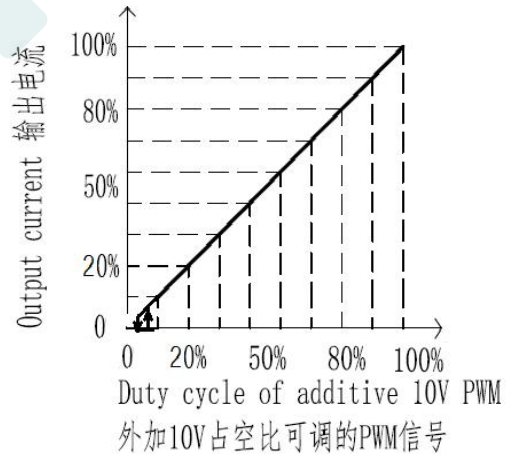

外加10V占空比可调的PWM信号

◎ Applying additive 0-100K resistance:

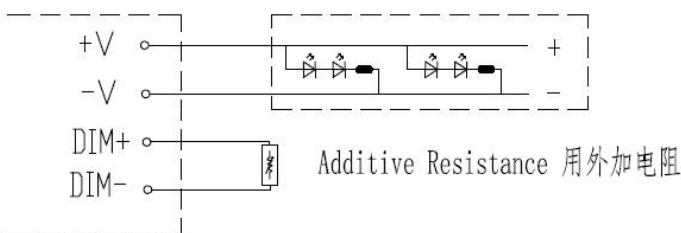

DO NOT connect "DIM- to -V" 请勿将DIM- 与-V相连

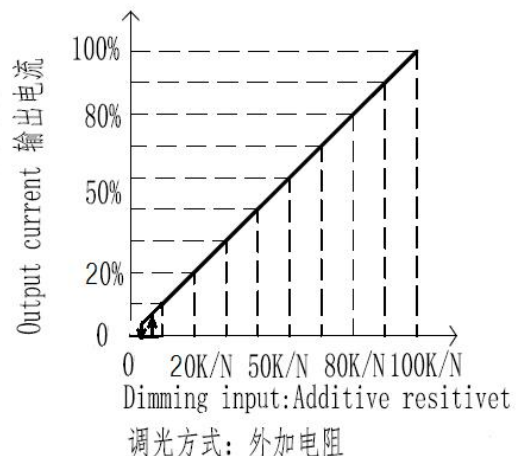

调光方式: 外加电阻

■ MACHINE SIZE MAP:

| | |
|-------------|--------------------|
| Size (mm) | L126mm*W41mm*H29mm |
|-------------|--------------------|

Case model : B40

unit:mm

DL-50W-V38A/58A-MAP

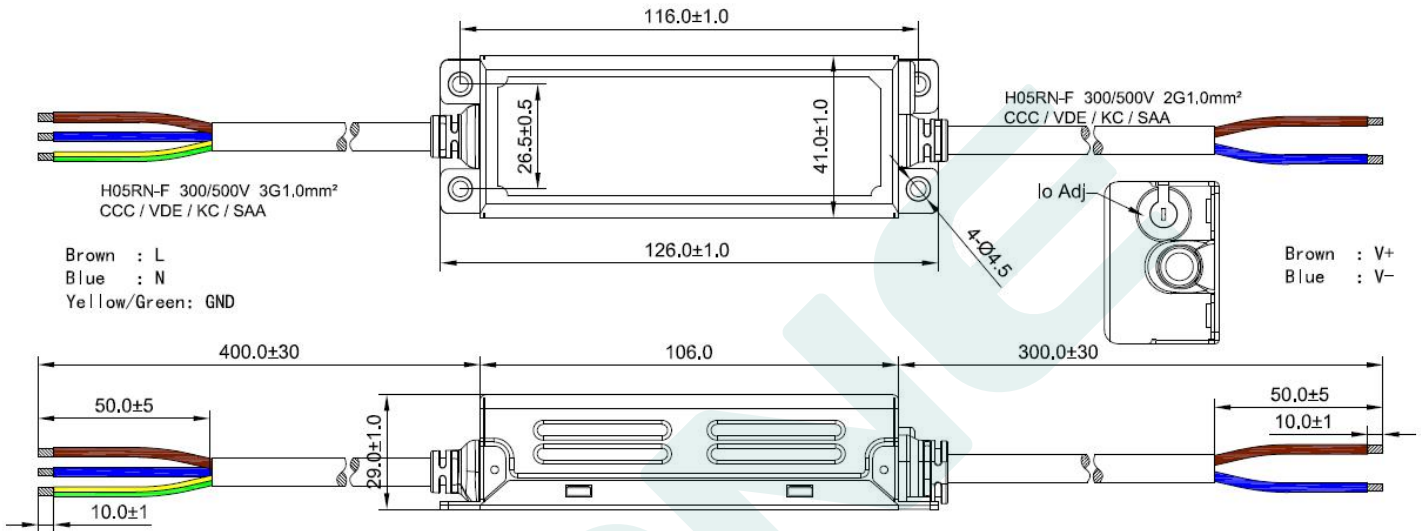

DL-50W-V38S/58S-MAP

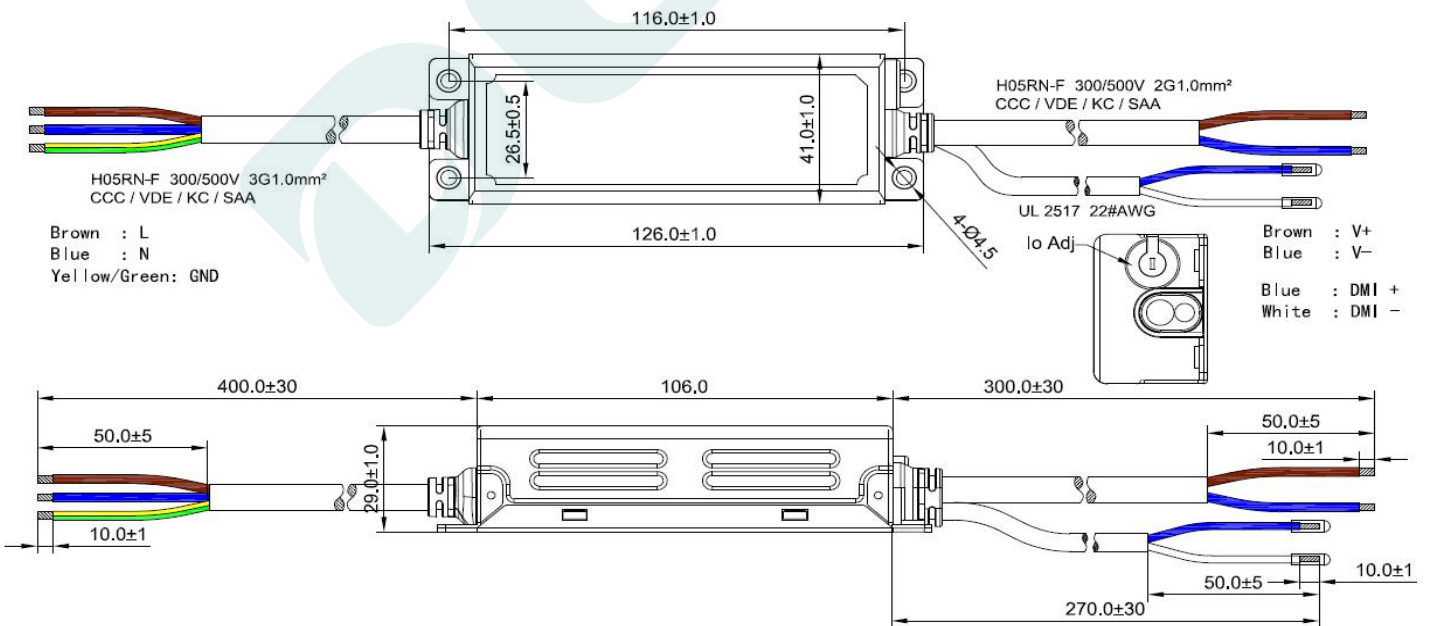

■ WEIGHT

| | |
|--------|------|
| Weight | 300g |
|--------|------|

■ PACKAGING

| | |
|------------------|----------------|
| Packaging (mm) | L475*W350*H205 |
|------------------|----------------|

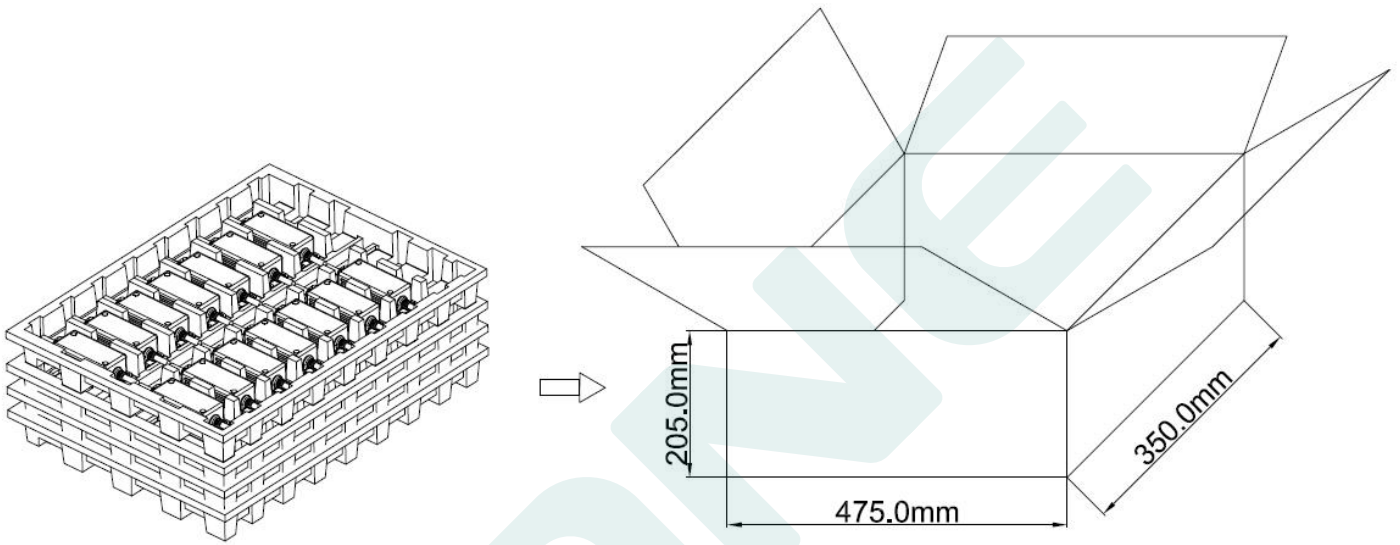

Remark : 56 drivers in a packing case